

# Forward-looking and energy efficient Biomass heating



**BioMatic**  
BIOCONTROL

220 - 500

- Large buildings
- Hotel systems
- Housing estate projects



# Advantages of the HERZ BioMatic system...



## Biomass furnace equipment for wood chips or pellets

- BioMatic BioControl 220 (power range **54 to 220 kW**)
- BioMatic BioControl 250 (power range **54 to 250 kW**)
- BioMatic BioControl 300 (power range **79 to 300 kW**)
- BioMatic BioControl 350 (power range **79 to 350 kW**)
- BioMatic BioControl 400 (power range **79 to 400 kW**)
- BioMatic BioControl 500 (power range **79 to 500 kW**)

## HERZ BioMatic BioControl: Unbeatably compact

- one of the most compact biomass systems available on the market
- smallest carry-in dimensions
- compact modular design (combustion chamber module and heat exchanger module)
- In most cases the system can be brought in to existing oil or gas plant rooms



## HERZ company data:

### HERZ Armaturen GmbH – The company

Founded in 1896, Herz has been continuously active in the market for more than 110 years. With five sites within Austria, another three in Europe and more than 1,500 employees at home and abroad, HERZ Armaturen GmbH is the only Austrian manufacturer that produces equipment for the entire heating and installation industry and is one of the most important internationally.

### HERZ Energietechnik GmbH

HERZ Energietechnik employs more than 150 staff in production and sales. At the company sites in Pinkafeld, Burgenland and Sebersdorf, Styria, there is state-of-the-art production as well as a research institute for new, innovative products. For a number of years, HERZ has worked with local research and training institutes. Over the years, HERZ has established itself as a specialist in renewable energy systems. HERZ places a great importance on modern, cost-effective and environmentally friendly heating systems with the highest level of convenience and user-friendliness.

### HERZ for the environment

All HERZ furnace systems fall below the strictest emission regulations. Numerous environmental endorsements bear witness to this.

### HERZ quality

HERZ designers are in constant contact with recognised research institutes in order to improve the very high standards even further.



# A detailed look at the BioMatic system...



## Optimum combustion via lambda probe control:



Automatic exhaust and combustion monitoring via lambda probe control

- Due to the installed lambda probe, which continuously monitors the exhaust values and reacts to different fuel qualities, it is possible to always obtain perfect combustion and the lowest emission values
- The lambda probe corrects the necessary fuel quantity and secondary air, thereby guaranteeing the cleanest combustion, for partial load operation too
- The result is low fuel consumption and the lowest possible emission values even when fuel quality varies

## Automatic cleaning:



- The surfaces of the standing pipe heat exchanger are automatically cleaned during boiler operation. This is carried out using integrated turbulators, a mechanism which guarantees a continued high level of efficiency between services by minimising heat lost to the exhaust
- Ash and clinker build-up on the combustion grate is automatically removed by a vibrating plate
- Ash thus generated in the base of the combustion chamber and heat exchanger modules is automatically conveyed to external ash boxes via independent augers

## Automatic control with BioControl 3000



- The control of heating systems by BioControl 3000 offers numerous advantages and facilitates the operation thanks to a simple screen design and a user-friendly menu
- The central control unit is fixed within the boiler frame reducing installation cost
- Furthermore, the BioControl 3000 offers integrated hot water supply, frost protection monitoring and holiday operation, as well as modular extension options in the form of insert cards for heating zones, buffer management, and solar circuit control

## Applicable fuels:



- pellets according to ÖNORM M 7135, DINplus seal of approval or Swissspellet
- wood chips G30-G50/W35 according to ÖNORM M 7133



## Safety devices in HERZ BioMatic systems (independent systems):



- Burn back protection device: falling chute and burn back flap driven by a sprung return motor prevents reverse air flow – a primary cause of burn back
- Burn back inhibiting device: two thermal monitoring points on the stoker screw trigger a sprinkler system if stoker temperatures continue to rise
- Electronically controlled stoker screw is automatically activated if the temperature increases



# The Innovative technology of HERZ BioMatic...

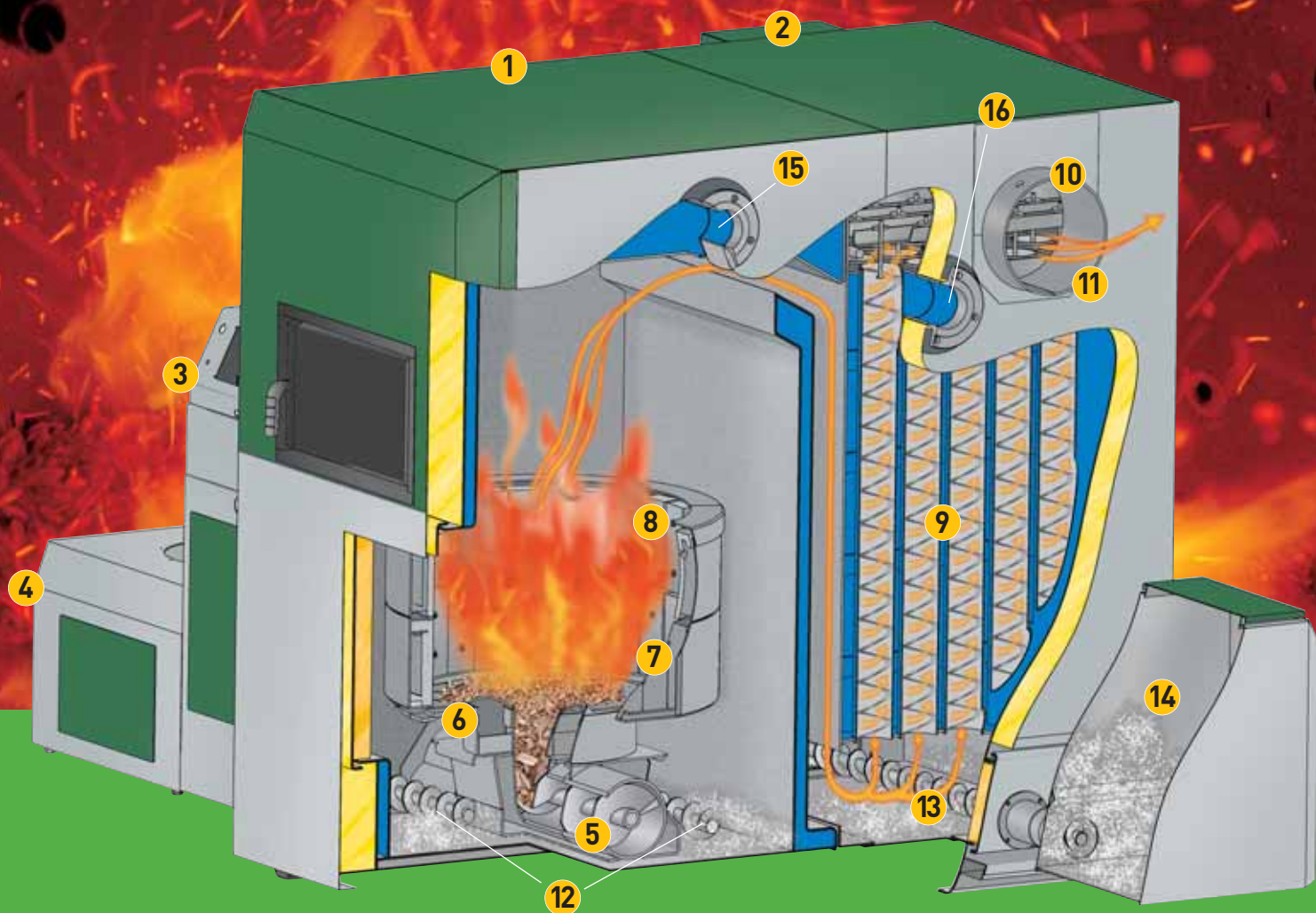

## Parts description:

- 1 Combustion chamber module
- 2 Heat exchanger module
- 3 Integrated control BioControl 3000
- 4 Intermediate hopper
- 5 Removable stoker screw
- 6 Automatic ignition using hot air blowers
- 7 Combustion chamber with automatic combustion cleaning (vibrating plate)
- 8 Split 2-zone –secondary air ring
- 9 Standing pipe heat exchanger with integrated turbulators and cleaning mechanism
- 10 Automatic exhaust and combustion monitoring via lambda probe control
- 11 Variable speed induced draught fan with combustion chamber under pressure control
- 12 Ash discharge screws for combustion ash
- 13 Ash discharge screw for fly ash
- 14 Fly ash container
- 15 Flow connection
- 16 Return connection

## Ash discharge systems for BioMatic:

Herz offers individual ash discharge systems to transport ash from standard BioMatic ash bins to external containers. Two options are available:

### Vacuum ash extractor:

Ash from the standard BioMatic ash bins and cyclone dust chamber is removed to an external store by a manually operated pneumatic suction lance.

Maximum height: 5m  
Maximum length: 20m

### Ash discharge using an auger:

Ash from the standard BioMatic ash containers and cyclone dust chamber is removed to an external store by an automatic auger system

# Information about the BioMatic boiler...

## Picture of a BioMatic system mounting:

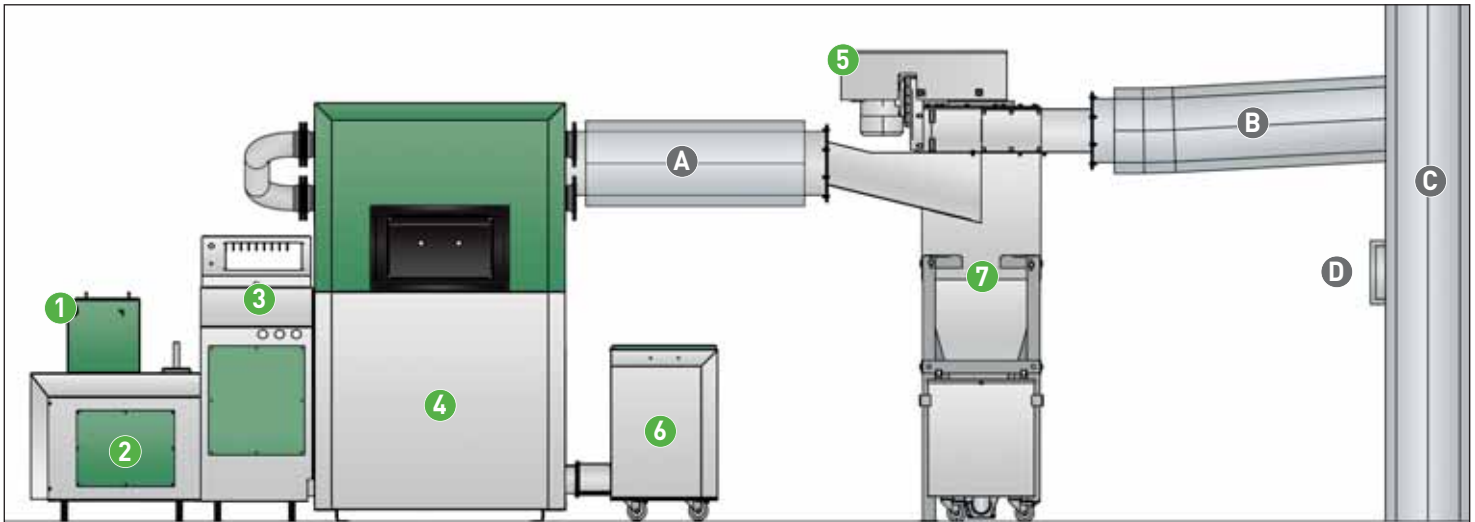

### BioMatic system installation:

- 1 Falling chute with burn back protection device
- 2 Intermediate hopper with removable stoker screw and burn back inhibiting device
- 3 Control for BioControl 3000
- 4 Boiler
- 5 Variable speed induced draught fan with combustion chamber under pressure control
- 6 Ash container
- 7 Flue gas dust extractor (dust chamber)

### Flue connections

#### (on the installation side):

- A flue pipe connection
- B Chimney connection with rising flue pipe
- C Twin walled insulated flue
- D Draught stabilizer

## HERZ discharge and drive technology:

All parts under the same roof!



Robust agitator with heavy duty gearing and pressure discharge.

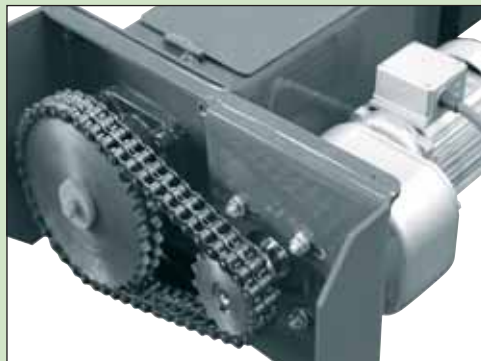

High quality drive motors with chain drive (dual chain). High starting torque and low power consumption.



Stable auger feed system for wood chips

# A perfect system from HERZ...

Use the HERZ BioControl 3000 to control heating circuits, boilers, buffers and solar systems.

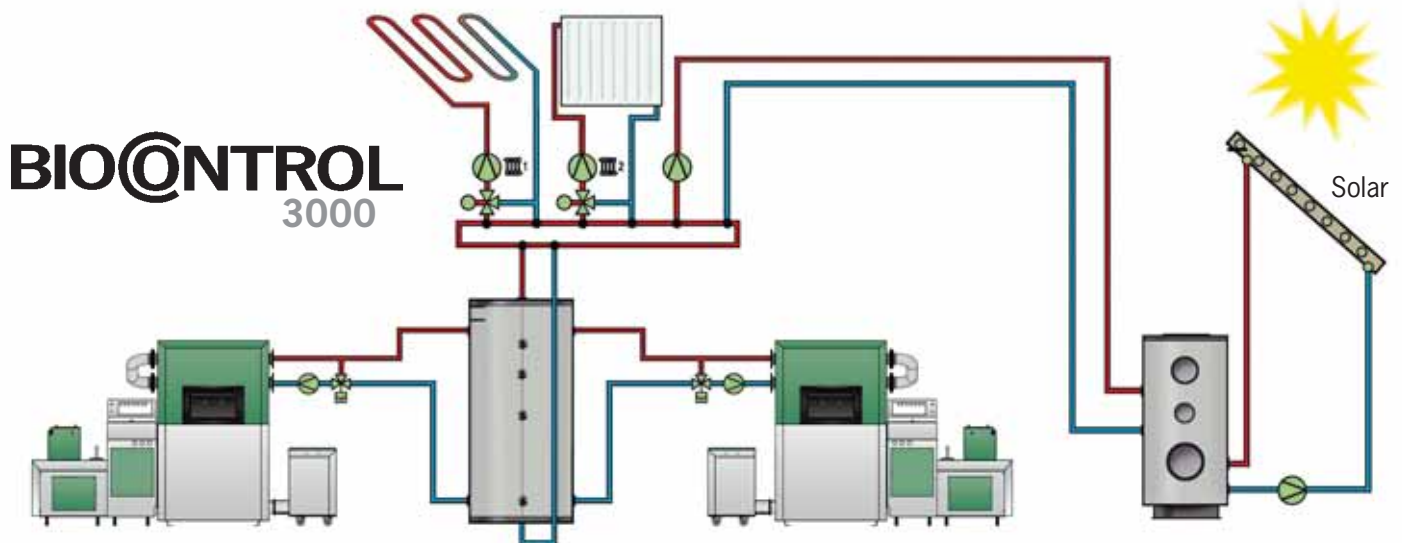

## Buffer storage:

Buffer storage is recommended, particularly for larger systems. It reduces the number of boiler start-ups, guarantees a continuous heat leak, and allows the boiler to optimise when it turns on. Using a buffer store, continuous power generation can be sustained for a longer period. Thus frequent cycling of the boiler can be avoided and the level of efficiency improved.

## Cascade switching:

Using the HERZ BioControl 3000, multiple HERZ boilers equipped with BioControl can be switched to cascade (CAN BUS). Cascade switching offers superior load profile matching, higher efficiency, and ensures even distribution of wear by automatically switching the lead role.

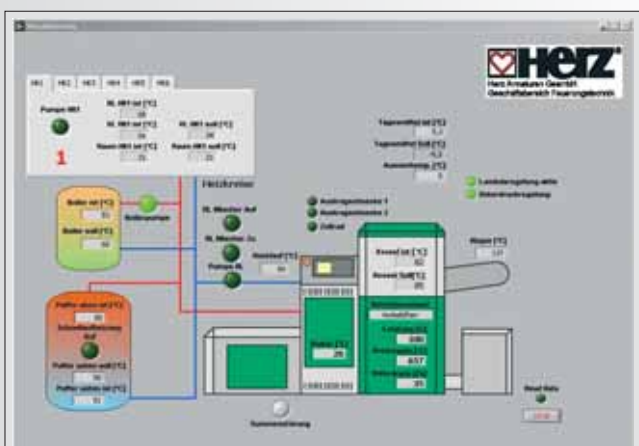

## HERZ remote monitoring and remote maintenance!

### Remote supervision (visualisation):

The current boiler values can be monitored on a PC via modem

### Remote maintenance:

Parameters that are released for visualisation can be modified on a PC using HERZ software.

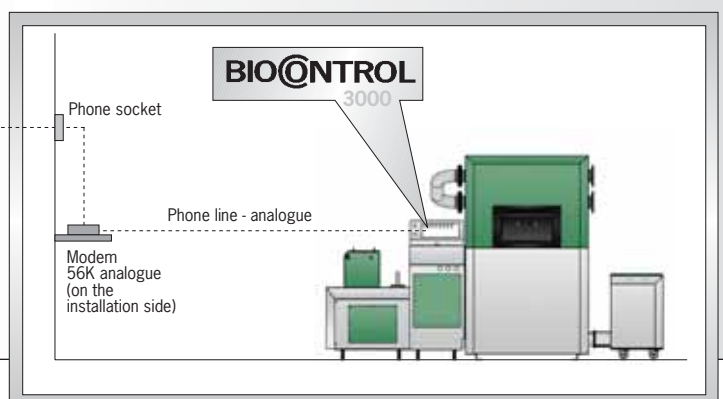
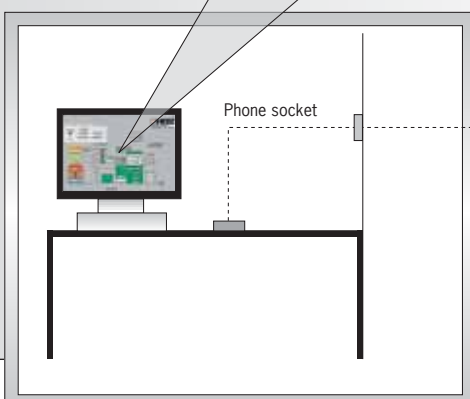



# The of the BioMatic!



## The controller that regulates the entire heating system.

# BIOCONTROL 3000



HERZ Buffer management



Domestic hot water processing



Cascade switching or additional heating



Weather compensated heating circuits



Solar equipment



Option of remote supervision and remote maintenance

# Discharge systems for...

HERZ fuel store discharge systems support various storage room designs and can be adapted to suit customer requirements.

An operation with wood chips is often the most effective solution to reduce fuel costs to the site

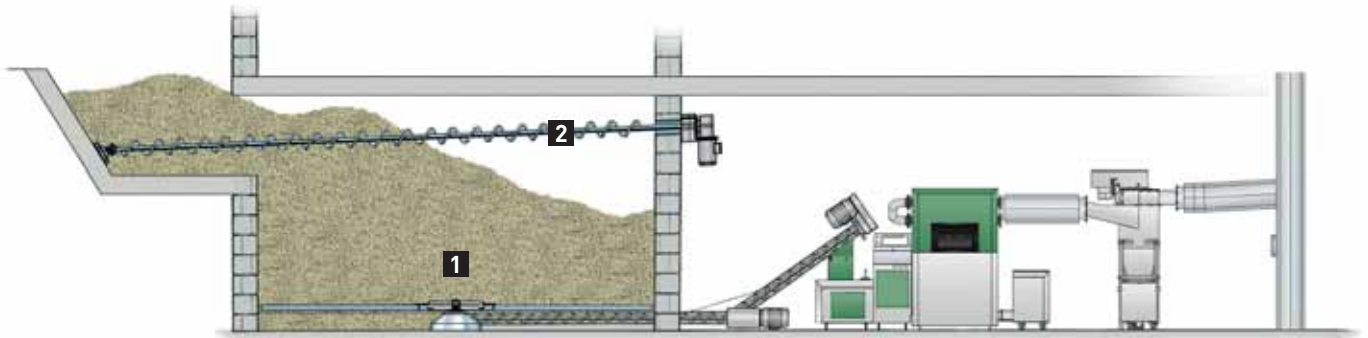

Storage room discharge via horizontal spring agitator (1) with rising screw allows optimum usage of the fuel storage room. The filling screw (2) distributes chip evenly during delivery

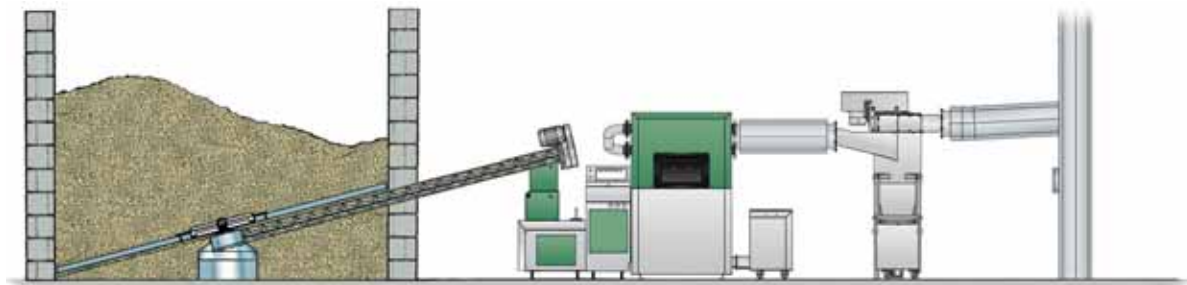

Storage room and heating room are on same level.  
Transversal discharge with spring agitator.

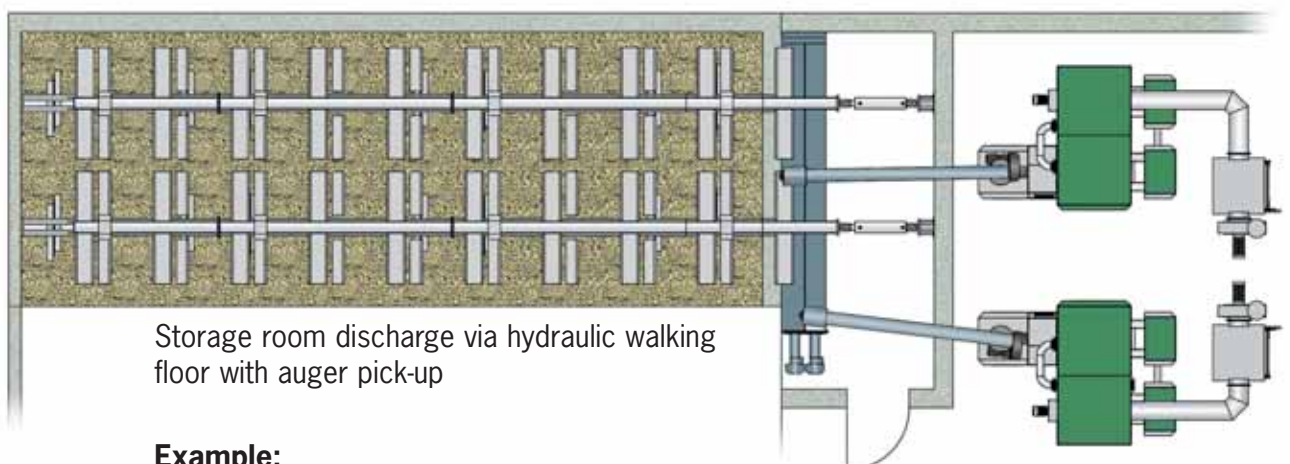

Storage room discharge via hydraulic walking floor with auger pick-up

**Example:**  
**2 BioMatic with cascade switching.**



# ...wood chips and pellets!

HERZ BioMatic: Environmentally friendly energy for heating residential dwellings, schools, nurseries and industrial buildings.

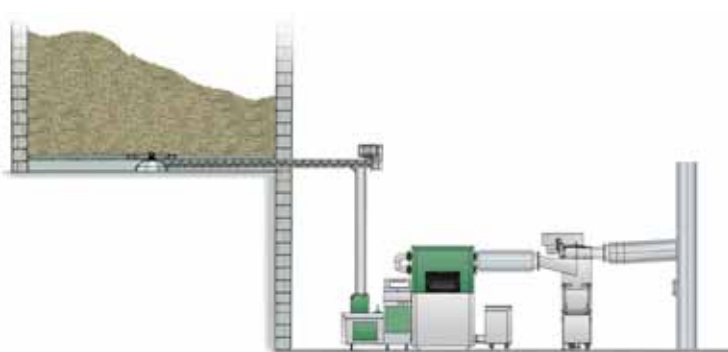

Storage room and plant room are on different levels. Horizontal discharge with spring agitator and falling chute.

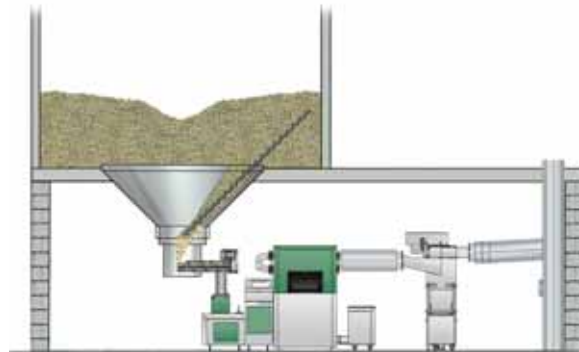

Storage room is above plant room. Discharge via pendulum screw from silo.

Pellet systems are characterized by the fact that they require little space for fuel storage.

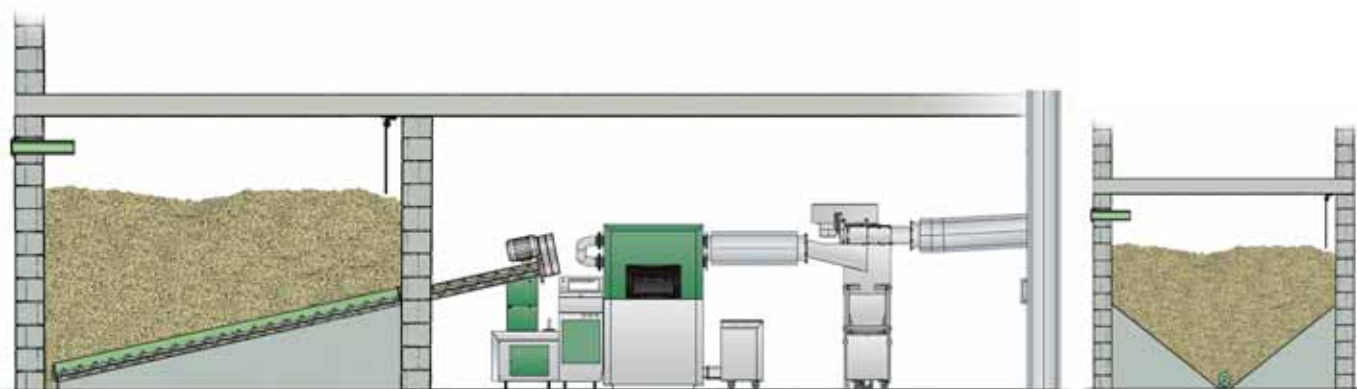

Transportation of pellets with inclined discharge screw.

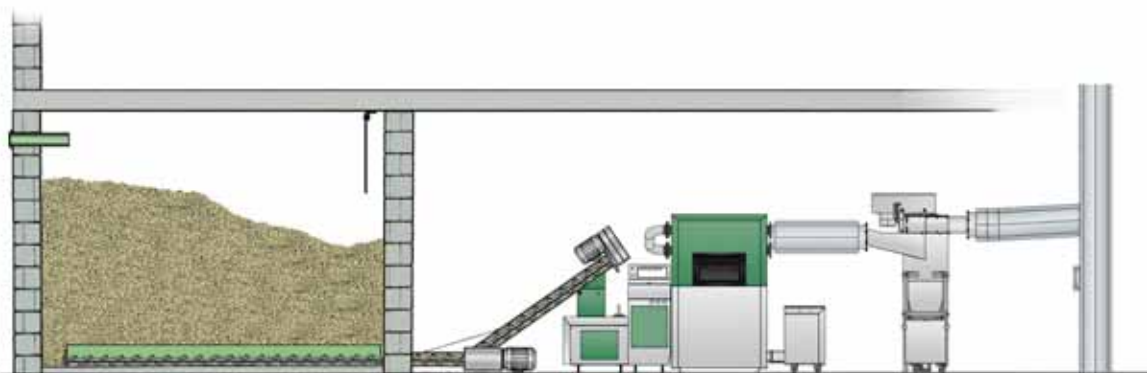

Horizontal pellet discharge from the storage room, with rising auger to optimise storage space.

For systems without a spring agitator the hopper base should slope at a minimum angle of 45 degrees towards the central auger



# The compact dimensions and technical data of HERZ BioMatic...

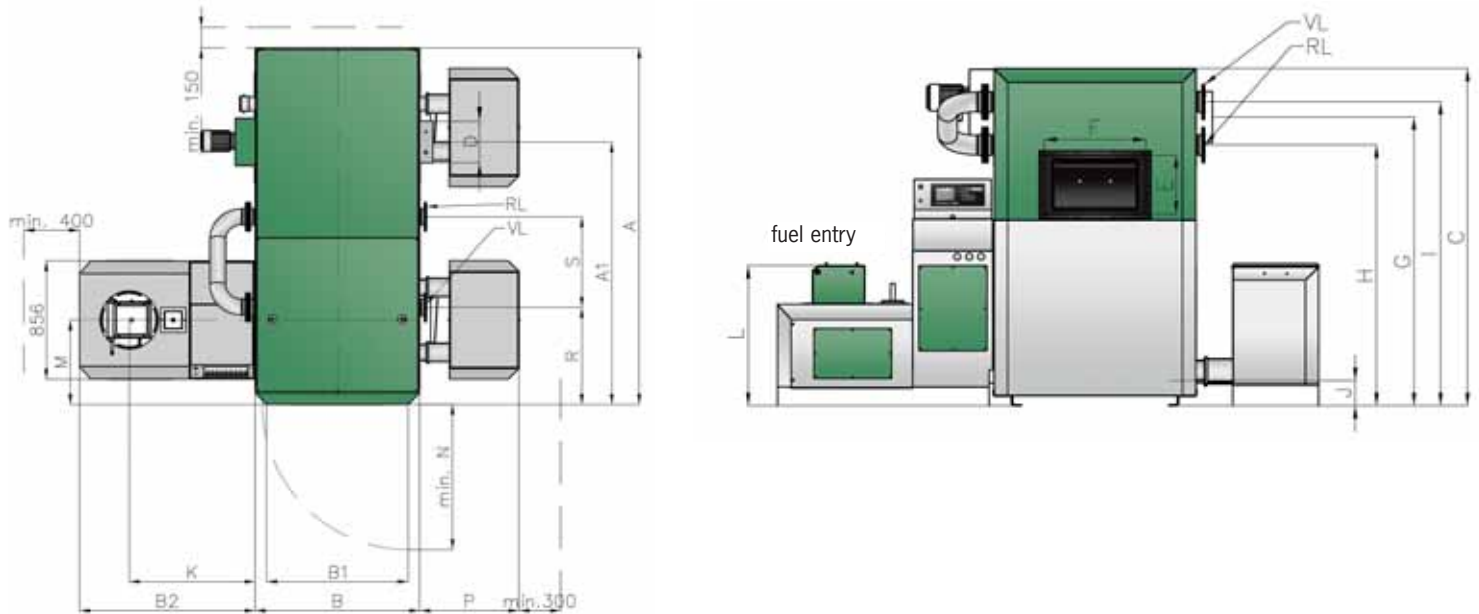

BioMatic Power range (kW)	220 54-220	250 54-250	300 79-300	350 79-350	400 79-400	500 79-500
<b>Dimensions (mm)</b>						
A Length	1948	1948	2054	2054	2574	2574
A1 Length to flue pipe centre	1516	1516	1635	1635	1895	1895
B Width	1066	1066	1186	1186	1186	1186
B1 Width (without flange)	862	862	986	986	986	986
Width (with flange)	1145	1145	1284	1284	1284	1284
B2 Width stoker module	1262	1262	1264	1264	1264	1264
C Height	1803	1803	1973	1973	1973	1973
D Flue pipe - diameter	250	250	300	300	300	300
E Combustion chamber doors - height	340	340	300	300	300	300
F Combustion chamber doors - width	500	500	500	500	500	500
G Flue pipe - centre	1481	1481	1688	1688	1688	1688
H Return flow connection dim [DN] / height	80/1335	80/1335	100/1523	100/1523	100/1523	100/1523
I Flow connection dim [DN] / height	80/1588	80/1588	100/1776	100/1776	100/1776	100/1776
J Filling/draining connection dim [ " ] / height	3/4" /148	3/4" /148	3/4" /148	3/4" /148	3/4" /148	3/4" /148
K BFP centre	904	904	906	906	906	906
L BFP height	822	822	822	822	822	822
M Boiler front to centre of BFP	539	539	610	610	610	610
N Front access requirement	min. 900	min. 900	min. 1050	min. 1050	min. 1050	min. 1050
P Ash box width	710	710	714	714	714	714
R Distance to centre of flow connection	646	646	701	701	701	701
S Distance from centre of flow to centre of return connection	605	605	655	655	655	655
<b>Technical data</b>						
Boiler weight	kg	2600	2600	2900	2900	3500
Min./max permissible flue draught requirement	mbar	0,05/0,15	0,05/0,15	0,05/0,15	0,05/0,15	0,05/0,15
Permissible operating pressure	bar	3	3	3	3	3
max. permissible flow temperature	°C	90	90	90	90	90
Volumetric water content	l	500	500	720	720	940
Electrical connection	V/Hz	3 x 400 / 50 Hz				
Heat exchanger surface	m <sup>2</sup>	11,8	11,8	16	16	26,6
Water resistance at Δt=20K	PA	2200	2200	2600	2600	3500
Water flow Δt=20K	kg/h	9483	9483	12931	12931	21552
<b>Emission values at full load</b>						
Exhaust temperature	°C	~140	~140	~140	~140	~140
Flue gas mass flow rate	kg/s	0,122	0,137	0,209	0,258	0,289
CO <sub>2</sub> contentVol. %		13,7	12,5	12,5	12,8	12,8
<b>Emission values at partial load</b>						
Exhaust temperature	°C	~80	~80	~85	~85	~85
Flue gas mass flow rate	kg/s	0,052	0,052	0,0787	0,0787	0,0787
CO <sub>2</sub> content	Vol. %	7,8	7,8	8,5	8,5	8,5

# HERZ BioMatic reference installations...

## HERZ BioMatic: Tailored to individual needs and successful in operation

- **Large buildings:** Hospitals, schools, public buildings, etc.
- **Hotel systems:** Heating of building, swimming pools, spa areas, etc.
- **Housing estate projects:** Heating of urban districts, family homes etc.
- **Wood-manufacturing productions:** Joinery, furniture producers, etc.



### Gloggnitz retirement home

- 2x350kW
- Discharge with dual spring agitators
- Heating of building with 123 care rooms
- Suction lance ash extractor



### Hatzen Dorf bio heating

- 2x500 kW
- 4-row walking floor discharge
- District heating of agricultural technical college, public and domestic buildings
- Suction lance ash extractor



### St. Martin local heating supply

- 2x500 kW
- 2-row walking floor discharge
- Heat supply for approximately 70 family houses
- Central ash screw discharge



### Hotel Cazorla (Spain)

- 2x400 kW
- Pellet screw discharge
- Heating of buildings, swimming pool and spa areas.

A detailed reference list can be supplied upon request.



# HERZ Customer-orientated...



- Advice during planning
- Planning of energy centre and fuel storage room
- Planning of chamber discharge according to customer requirements and local conditions
- Planning of installation according to customer requirements
- Comprehensive services
- HERZ training:
  - for the machine operator
  - for designers and technical offices
  - for pipe fitters and installers
  - as well as continuous training of the maintenance staff

www.grafikorange.com

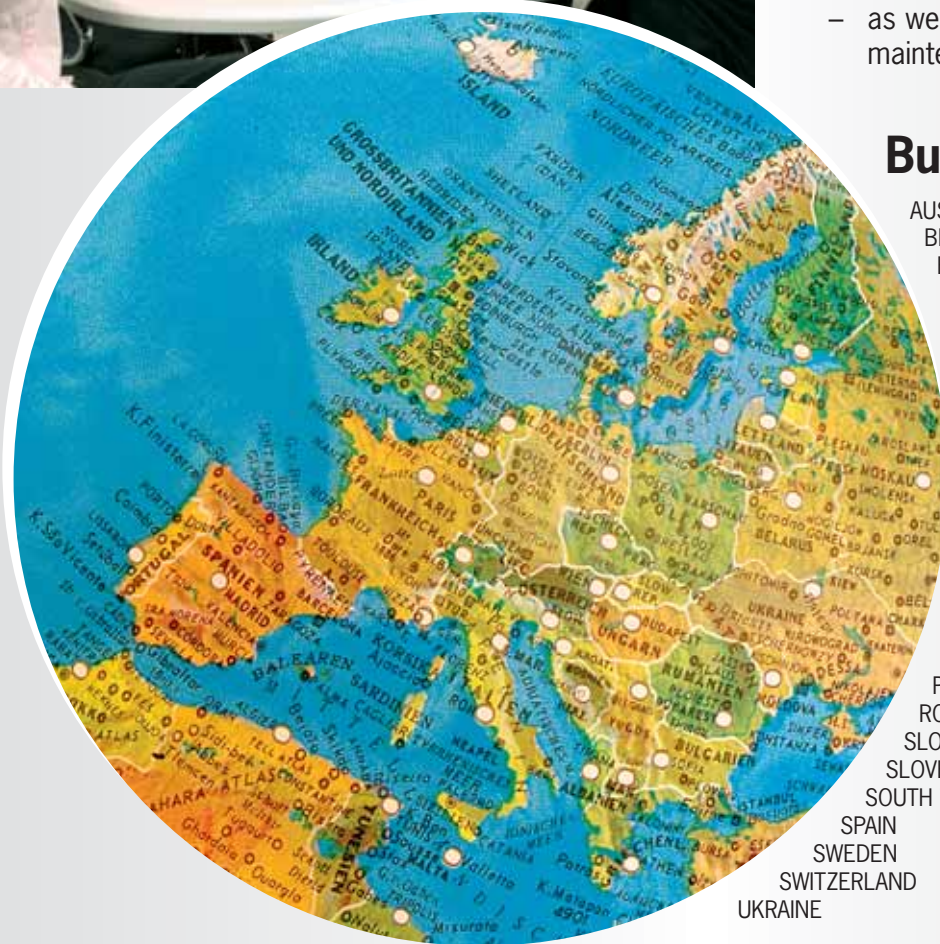

## Business partners in:

- AUSTRIA
- BELGIUM
- BULGARIA
- CROATIA
- CZECH REPUBLIC
- DENMARK
- FINLAND
- FRANCE
- GERMANY
- GREAT BRITAIN
- GREECE
- HUNGARY
- IRELAND
- ITALY
- LATVIA
- LUXEMBOURG
- NETHERLANDS
- POLAND
- ROMANIA
- SLOVAKIA
- SLOVENIA
- SOUTH TYROL
- SPAIN
- SWEDEN
- SWITZERLAND
- UKRAINE

The right to make technical amendments is reserved. GB-112010

Your partner:



HERZ-Feuerungstechnik exceeds the strict emission regulations.



HERZ Energietechnik GmbH  
 Herzstraße 1, 7423 Pinkafeld  
 Österreich/Austria  
 Tel.: +43(0)3357/42840-0  
 Fax: +43(0)3357/42840-190  
 Mail: office-energie@herz.eu  
 Internet: www.herz.eu